

# FORD

## ROTARY CUTTER SERIES 908

# Operator's Manual

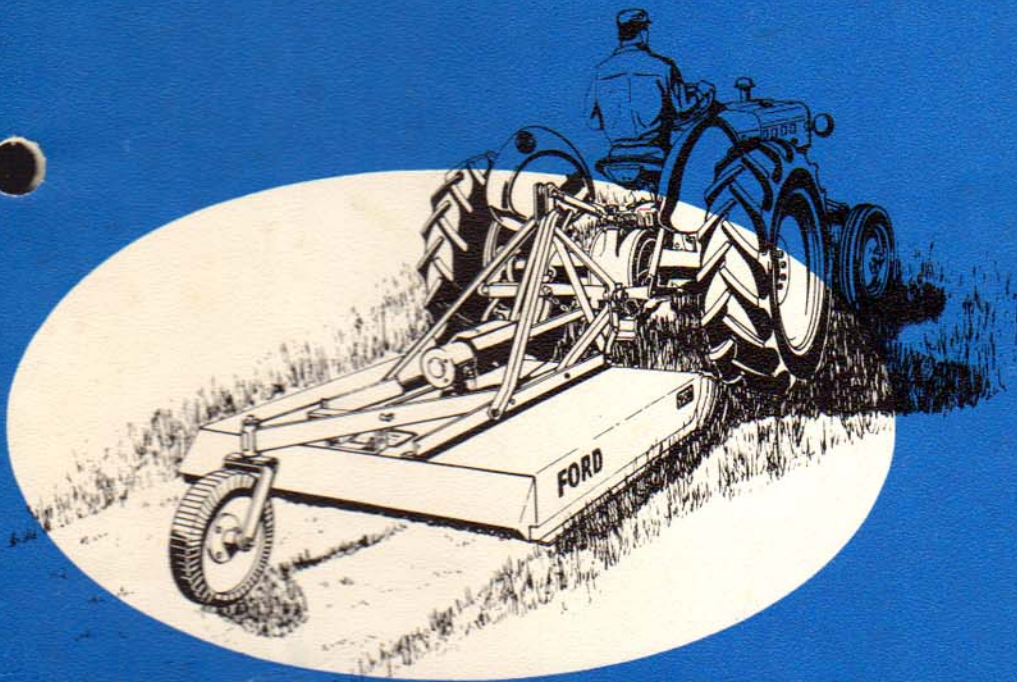

Ford Tractor Operations

# TABLE OF CONTENTS

	<i>Page</i>
<b>SAFETY PRECAUTIONS</b> . . . . .	4
<b>PRE-OPERATION</b> . . . . .	5
<b>Preparing the Tractor</b> . . . . .	5
Wheel Spacing . . . . .	5
Tractor Weighting . . . . .	5
Tractor Drawbar . . . . .	5
Lift Linkage . . . . .	6
Attaching the Cutter . . . . .	6
Height-of-Cut-Adjustment . . . . .	6
Cutters without Gauge Wheel or Flexible A-Frame Bracket . . . . .	6
Cutters with Gauge Wheel, but without Flexible A-Frame Bracket . . . . .	6
Cutters with Gauge Wheel and Flexible A-Frame Bracket . . . . .	7
<b>OPERATION</b> . . . . .	7
Clearing the Cutter . . . . .	7
Transporting the Cutter . . . . .	7
Detaching the Cutter . . . . .	8
<b>LUBRICATION</b> . . . . .	8
Lubrication Fittings . . . . .	8
Gearbox . . . . .	8
<b>MAINTENANCE</b> . . . . .	8
Cutting Blade Replacement . . . . .	8
Blade Carrier Replacement . . . . .	9
Shear Bolt Drive Lines . . . . .	10
Slip Clutch Drive Lines . . . . .	10
<b>STORAGE</b> . . . . .	11
<b>ATTACHMENTS</b> . . . . .	11
<b>SHIPPING INFORMATION</b> . . . . .	13
<b>ASSEMBLY</b> . . . . .	14

# SAFETY PRECAUTIONS

The following precautions are suggested to help prevent accidents.

1. Read this manual carefully to acquaint yourself with the Rotary Cutter. Working with unfamiliar equipment can lead to accidents.
2. Use the handholds and step plates when getting on and off the tractor.
3. Familiarize yourself with all controls before attempting to operate the tractor.
4. Never start the engine while standing beside the tractor. Always sit in the tractor seat while starting the engine.
5. Do not bypass the safety starter switch. Consult your Ford Tractor-Equipment Dealer if your safety starter controls are malfunctioning.
6. Always use the seat belt only when the roll bar is installed. Never use the seat belt if the roll bar is removed from the tractor.
7. Do not permit anyone to ride on the tractor with the operator.
8. Never allow anyone to ride on the cutter.
9. Use care when operating on steep grades to maintain proper stability.
10. Keep the tractor in gear when going downhill.
11. Always keep the tractor brakes in good operating condition.
12. Never run the tractor engine in a closed building without adequate ventilation, as the exhaust fumes are very dangerous.
13. Always drive the tractor at speeds compatible with safety, especially when operating over rough ground, crossing ditches, slopes, or when turning.
14. Always use the drawbar for pull-type work. Never pull from the upper link or rear axle as the tractor can tip backward.
15. If the tractor is stuck, back out to prevent an upset. If logs are used, always put them behind the rear wheels and back out.
16. If the front end tends to rise, install front end or front wheel weights. Do not continue to operate with a "light" front end.
17. Use the flasher warning lamp when traveling on public roads, day or night, unless prohibited by law in your state.
18. Always bring the tractor to a complete stop, and shut off the engine before getting off the tractor.
19. Never park the tractor on a steep incline.
20. Never leave equipment in the raised position.
21. The operator should never get off the tractor while it is in motion..
22. When operating P.T.O.-driven equipment, always shut off the engine and wait for the P.T.O. to stop turning before getting off the tractor and before disconnecting the equipment..
23. Never wear loose clothing when operating the power take-off, or around equipment that is rotating.
24. When operating stationary P.T.O. equipment, always apply the parking brake and block the rear wheels both in front and back.
25. Never clean or adjust P.T.O.-driven equipment with the tractor engine running.
26. Make sure the P.T.O. shield is installed when using P.T.O.-driven equipment, and always replace the P.T.O. shield if damaged.
27. Always set the hydraulic selector lever in Position Control when attaching equipment, transporting equipment, and when no equipment is attached.
28. Never allow an open flame near the fuel tank or battery.

Whenever you see this symbol



it means:

**ATTENTION! BECOME ALERT!  
YOUR SAFETY IS INVOLVED!**

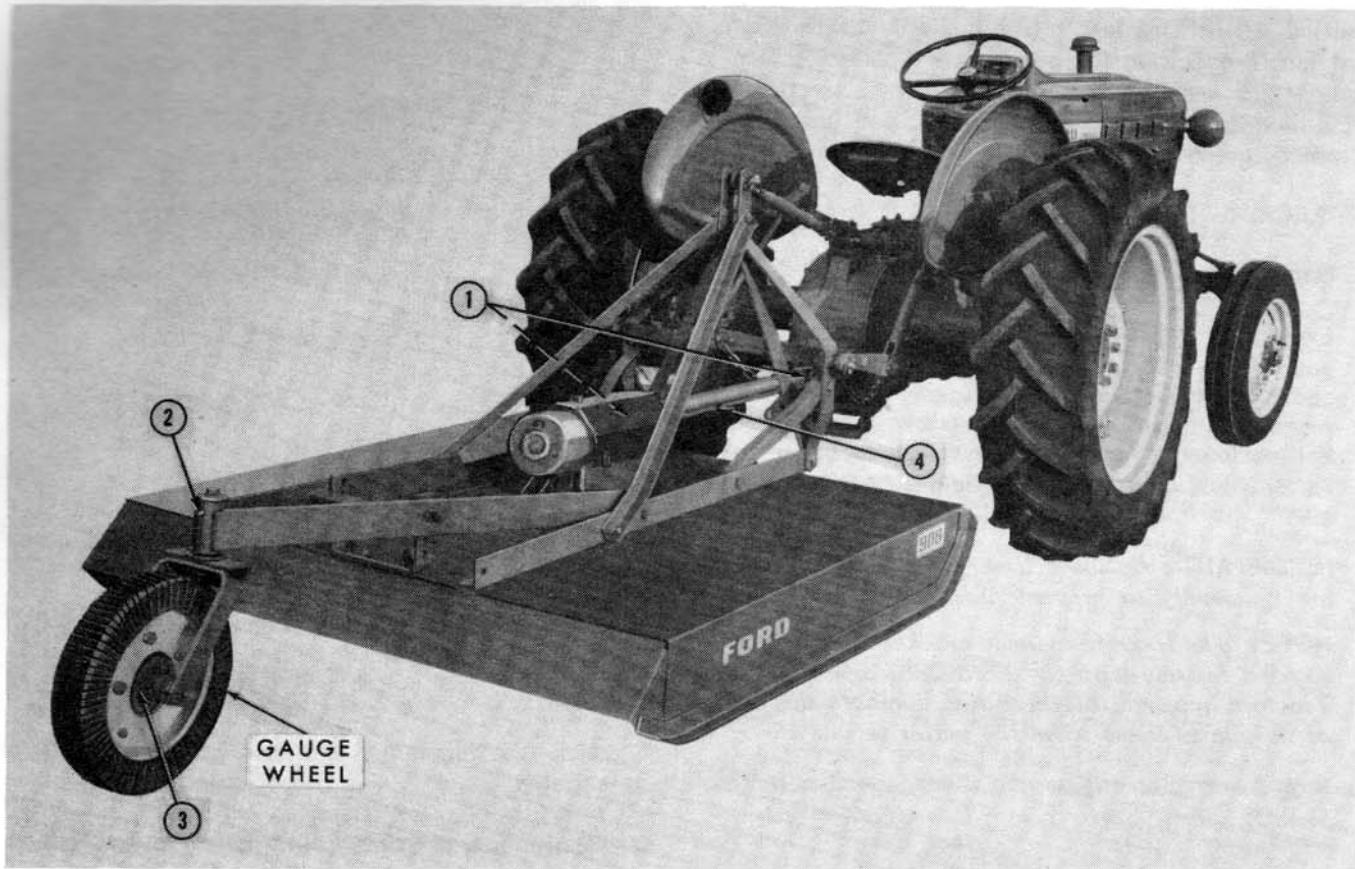

*Figure 1*  
*Series 908 – 60-Inch Rotary Cutter*

## GENERAL INFORMATION

The Ford 60-Inch, Series 908 Rotary Cutter, Figure 1, is a light-duty rotary blade cutter that is recommended for light-to-medium cutting, such as encountered in maintenance of pastures, airports, parks, vineyards, and orchards.

The cutter is designed for 540 rpm P.T.O. operation with tractors of 40 horsepower or less that have Category I lift linkage. A choice of drive lines and blade carriers are available. They are:

- Shear bolt drive line with standard or round blade-carrier.
- Slip clutch drive line with standard or round blade-carrier.

For information pertaining to the various attachments that are available, refer to page 11. The attachments may be purchased from your Ford Tractor-Equipment Dealer.

## PREPARING THE TRACTOR

### WHEEL SPACING

The crop mashed down by the right-hand tractor wheels can be cut clean by setting the tractor right-hand wheels so the inside of the tires are outside of the area to be cut. This setting will provide a better cutting appearance, and allow a counterclockwise cutting of the work area. Clockwise cutting will cause the tractor right-hand tires to run over the un-cut material on each round.

### TRACTOR WEIGHTING

To provide better tractor stability when the cutter is operating over uneven terrain, the front of the tractor should be weighted with cast iron weights and/or the front tires should be filled with liquid ballast as outlined in your Tractor Operator's Manual.

### TRACTOR DRAWBAR

Remove the tractor drawbar to prevent possible interference during cutter operation.

## LIFT LINKAGE

Set the left lift link length (if adjustable) to the nominal length specified in your Tractor Operator's Manual. Attach optional lower link stabilizers to prevent side-to-side movement of the cutter. See your Ford Tractor-Equipment Dealer.

## ATTACHING THE CUTTER

1. Back the tractor to the cutter.
2. Lower the tractor hydraulic lift control lever and secure the tractor lower links, Figure 2, to the cutter hitch pins. Secure the links with linch pins. Attach the upper link to the flexible A-frame bracket (optional equipment); then adjust the upper link as outlined below under "Height-Of-Cut-Adjustment".

**IMPORTANT:** *Optional lower link stabilizer bars are necessary to prevent side-to-side movement.*

**NOTE:** *The flexible A-frame bracket is not recommended for use with the Ford 2110 or 4110 LCG Tractors because the drive line contacts the front of the cutter frame when the cutter is raised.*

3. Stop the tractor engine and disengage the tractor P.T.O.
4. Remove the tractor P.T.O. shaft cover and place a few drops of oil on the P.T.O. shaft.

**IMPORTANT:** *Check to be sure that the tractor P.T.O. shaft is a 6-spline shaft, and that the tractor P.T.O. speed shift lever (if installed) is positioned to operate at 540 rpm.*

5. Push the spring-loaded pin, shown at (1), Figure 2, on the cutter drive shaft, inward; then slide the universal joint over the tractor P.T.O. shaft until the pin locks in place. If the tractor P.T.O. shaft is not grooved to accommodate the spring-loaded pin, secure the universal joint to the shaft with a 5/16" x 2-1/2" machine bolt, lock washer, and nut.
6. Install the tractor P.T.O. shaft shield.

## HEIGHT-OF-CUT ADJUSTMENT

To achieve maximum cutting efficiency and provide the most uniform cut, the cutter is normally operated in a level position. However, in heavy cutting, it may be desirable to operate with the front of the cutter slightly higher than the rear. Height-of-cut leveling adjustments are as follows:

### Cutters without Gauge Wheel or Flexible A-Frame Bracket

1. Place the tractor hydraulic selector lever in position control.

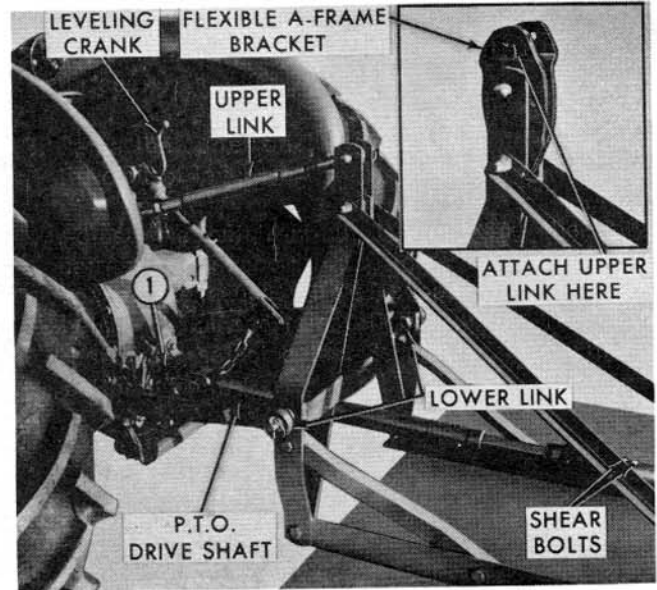

**Figure 2**  
Cutter Attached to the Tractor – P.T.O. Shield  
Removed for Illustration Purposes

2. Move the tractor and attached cutter to a level surface.
3. *Slowly* lower the cutter with the hydraulic lift control lever to the desired height-of-cut. Then position the adjustable stop on the quadrant against the lift control lever so the cutter can be returned to the same cutting height.
4. Level the cutter front-to-rear with the adjustable upper link, Figure 2, so the front of the cutter is 1/2 to 1 inch higher than the rear.
5. Level the cutter side-to-side with the right-hand lift link leveling crank.

### Cutters with Gauge Wheel, but without Flexible A-Frame Bracket.

1. Place the tractor hydraulic selector lever in draft control.
2. Move the tractor and the attached cutter to a level surface.
3. Raise the cutter off the ground with the hydraulic lift control lever.
4. Adjust the height-of-cut by removing the cutter hairpin and support rod, Figure 3, then raise or lower the gauge wheel support to the desired height of cut and reinstall the support rod in the respective set of holes. Secure in place with the cutter hairpin.

# OPERATION

5. Lower the cutter *very slowly* until the gauge wheel rests on the ground. Then position the adjustable stop on the quadrant against the lift control lever so the cutter can be returned to the same cutting height.
6. With the engine running, lengthen or shorten the adjustable upper link as required until the front of the cutter is 1/2 to 1 inch higher than the rear.
7. Level the cutter side-to-side with the right-hand lift link leveling crank, Figure 2.

## Cutters with Gauge Wheel and Flexible A-Frame Bracket

1. Place the tractor hydraulic selector lever in position control.
2. Move the tractor and the attached cutter to a level surface.
3. Raise the cutter off the ground with the hydraulic lift control lever.
4. Adjust the height-of-cut by removing the cotter hairpin and support rod, Figure 3, then raise or lower the gauge wheel support to the desired height of cut and reinstall the support rod in the respective set of holes. Secure in place with the cotter hairpin.
5. Lower the cutter *very slowly* until the gauge wheel rests on the ground and the cutter is level front-to-rear, or until the front of the cutter is 1/2 to 1 inch higher than the rear. Then position the adjustable stop on the quadrant against the lift control lever so the cutter can be returned to the same cutting height.

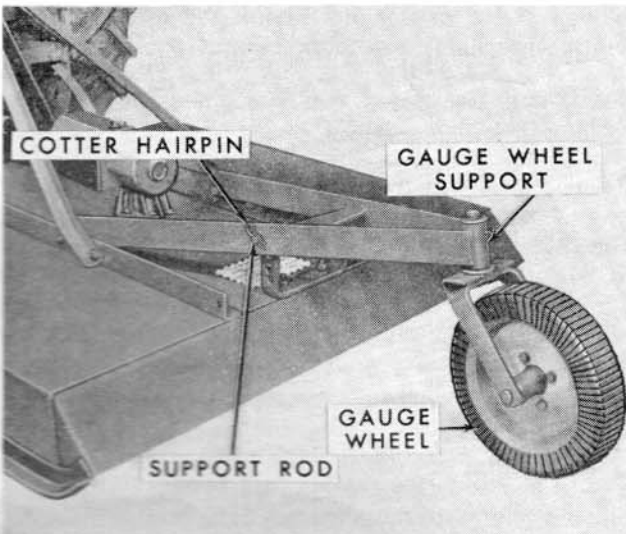

Figure 3  
Gauge Wheel Attachment

6. Turn the adjustable upper link so the pin in the flexible A-Frame bracket Insert, Figure 2, is centered in the slot.
7. Level the cutter side-to-side with the right-hand lift link leveling crank, Figure 2.

**NOTE:** *The cutter should not be dragged on the cutter skid shoes.*

## OPERATION

1. With the engine operating at a low rpm, ease the P.T.O. control handle very slowly into the operating position. On Select-O-Speed-equipped tractors, pull the P.T.O. control handle out approximately 1/4 inch, wait 3 to 5 seconds (until the P.T.O. shaft starts to turn), then pull it out all the way to the operating position.

**IMPORTANT:** *Operate the rotary cutter at 540 rpm P.T.O. speed only.*

2. Ease up on the clutch pedal to slowly move the cutter into the load and to prevent drive line clutch slippage, or the shear bolts from shearing. Start with a steady pull -- *never* with a jerk.
3. Set the tractor ground speed to where the best cut is obtained. Excessive tractor speed will result in a poor cut of the work area. Select a gear that will provide a smooth cut.
4. Select the direction of travel to provide a smooth, clean, cut of the area. Generally, a counterclockwise direction of travel will result in the best performance.

**NOTE:** *The cutter should not be operated in rocky or stumpy areas. Due to the high speed of the cutting blades, damage may result if the cutter is operated where such obstructions are present.*

## CLEARING THE CUTTER

Clear a clogged cutter by stopping the tractor, disengaging the P.T.O., and raising the cutter off the ground. When the cutter is clear of trash, move the tractor forward ahead of the trash, lower the cutter, then resume operation.

## TRANSPORTING THE CUTTER

Raise the cutter completely off the ground during transport to prevent premature wear of the gauge wheel, if so equipped. Always place the P.T.O. control handle or lever to the disengaged position when transporting the cutter.

## DETACHING THE CUTTER

Disengage the P.T.O. and disconnect the cutter drive shaft from the tractor P.T.O. shaft. Push the shaft into the tube as far as possible to prevent it from contacting the ground. If the cutter is to be stored for an extended length of time, lower the cutter onto blocks under each skid shoe to prevent the unit from rusting. Disconnect the 3-point linkage, then carefully drive the tractor away from the cutter.

## LUBRICATION

### LUBRICATION FITTINGS

Drive Shaft Universal Joints . . . . one fitting at each universal joint (1), Figure 1

Drive Shaft Telescoping Point . . . . one fitting at the telescoping area (4), Figure 1

Gauge Wheel Axle . . . . . one fitting on the wheel hub (3), Figure 1

Gauge Wheel Support . . . . . one fitting in the support hub (2), Figure 1

Lubricate the cutter after every four hours of operation with a good grade of pressure gun grease. Use a sufficient amount of new grease to force out the old dirt-encrusted grease. One stroke of the grease gun is usually sufficient.

### GEARBOX

The gearbox on the 60-inch, Series 908 Cutter, is factory-lubricated with a high grade industrial-type grease that is normally good for the life of the cutter. Generally, it is *not* necessary to add grease to the gearbox. However, if seal damage is encountered or the gearbox was disassembled for overhaul, then the gearbox should be replenished with the specified amount of clean multi-purpose lithium base grease, Part No. 5PM-1C57-A. Factory-fill capacity of the gearbox is 18 ounces.

**IMPORTANT:** *Clean 5PM-1C57-A or ESEN-MIC-137A multi-purpose lithium base grease should be used in the gearbox. Never use oil or the wrong type of grease, or fill the gearbox more than specified. See your Ford Tractor-Equipment Dealer for the specified type of grease.*

## MAINTENANCE

Check all nuts and bolts at regular intervals to be sure they are in place and are tight. Inspect the blades periodically and replace if excessively worn.

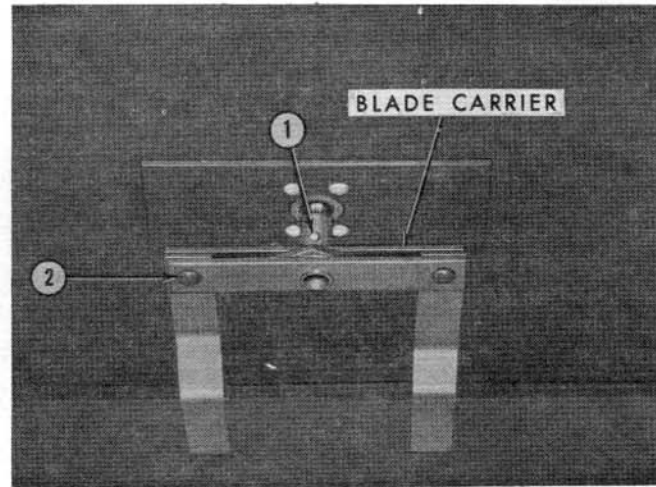

Figure 4  
Cutter Blades Installed - Model 22-194

### CUTTING BLADE REPLACEMENT

After the cutter has been used for a considerable length of time, one or both cutting blades will become worn or possibly damaged. If only one blade becomes worn or damaged, always replace both of them to maintain proper balance. If the blade bolts show wear they should also be replaced.

#### Model 22-194

**Removal:** Remove the blades from the standard blade carrier by removing the cotter pins, slotted hex nuts, carriage bolts, and spacers at (2), Figure 4.

**Installation:** Attach the replacement blades to the standard blade carrier by first placing a spacer in the attaching hole, then place the blades between the two halves of the carrier and install the carriage bolts, slotted hex nuts, and cotter pins at (2), Figure 4.

#### Model 22-195

**Removal:** Loosen the access cover retaining nut and swing the cover away from the access opening, Figure 5. Turn the round blade-carrier so one of the blade attaching nuts is directly under the access opening, then remove the self-locking hex nut, shoulder bolt, and blade. Turn the carrier until the opposite blade attaching nut is under the access opening, then remove the second nut, bolt, and blade.

**Installation:** Working through the access opening, Figure 5, attach the replacement blades to the round blade-carrier with the shoulder bolts and self-locking hex nuts. Tighten the nuts to 300 lbs. ft. Position the access cover over the access opening and tighten the attaching bolt nut.

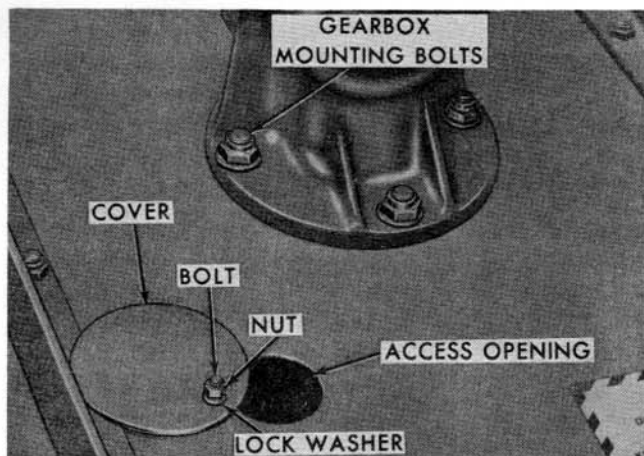

**Figure 5**  
**Blade Bolt Access Opening – Model 22-195**

## BLADE CARRIER REPLACEMENT

Normally, it is not necessary to remove the blade carrier; however, if it should become damaged it can be removed and a service replacement installed as follows:

### Model 22-194

**Removal:** Remove the standard blade carrier from the gearbox output shaft by removing the hex nut and bolt at (1), Figure 4.

### Installation:

1. Clean the splines on both the carrier and output shaft, then grease the cleaned areas.
2. Position the standard blade carrier on the gearbox output shaft and retain it with the grade No. 5 bolt and hex nut at (1), Figure 4.

### Model 22-195

### Removal:

1. Remove the cotter pin, then loosen the slotted hex nut on the end of the gearbox output shaft. Do not remove the nut until after the carrier is loosened.

**NOTE:** Because the gearbox output shaft has tapered splines, and the nut is torqued to 400 lbs. ft., block the blade carrier to keep it from turning, as shown in Figure 6, with a length of 2 x 4 that will reach from the carrier to the ground.

2. Once the nut is loose, back it off 2 or 3 turns, then using a puller and hammer as shown in Figure 7, loosen the carrier. Tighten the puller to heavily pre-load the carrier, then strike the puller forcing screw several times with a hammer. Remove the puller, nut, washer, and carrier.

### Installation:

1. Clean the splines on both the carrier and output shaft, then grease the cleaned areas.

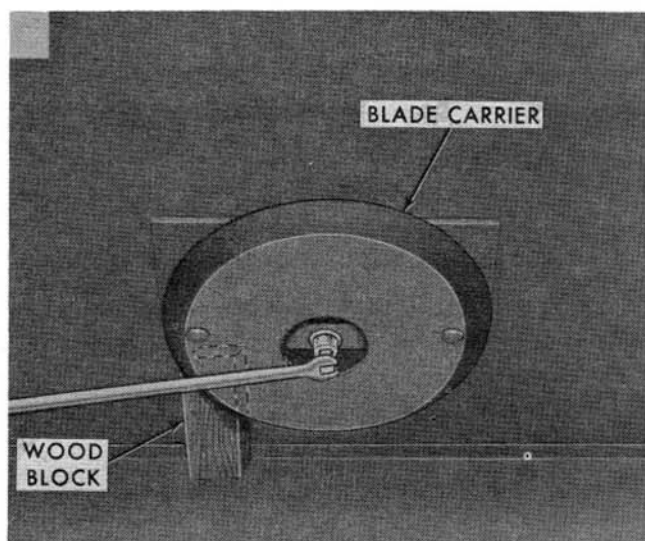

**Figure 6**  
**Loosening Blade Carrier Nut – Model 22-195**

2. Position the blade carrier on the gearbox output shaft, then install the flat washer and slotted hex nut. Block the carrier to keep it from turning and tighten the nut to 400 lbs. ft.
3. Using a sleeve and hammer against the hub of the carrier as shown in Figure 8, strike the sleeve several times to seat the tapered splines of the output shaft. Retighten the nut to 400 lbs. ft. Install the cotter pin.

**IMPORTANT:** Do not back off the nut to install the cotter pin. If the holes do not line up, repeat Step 3 until the cotter pin can be installed.

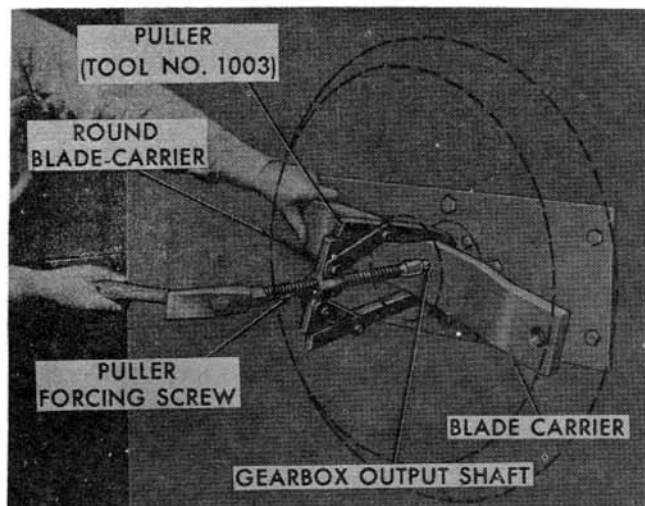

**Figure 7**  
**Removing Blade Carrier – Model 22-195**



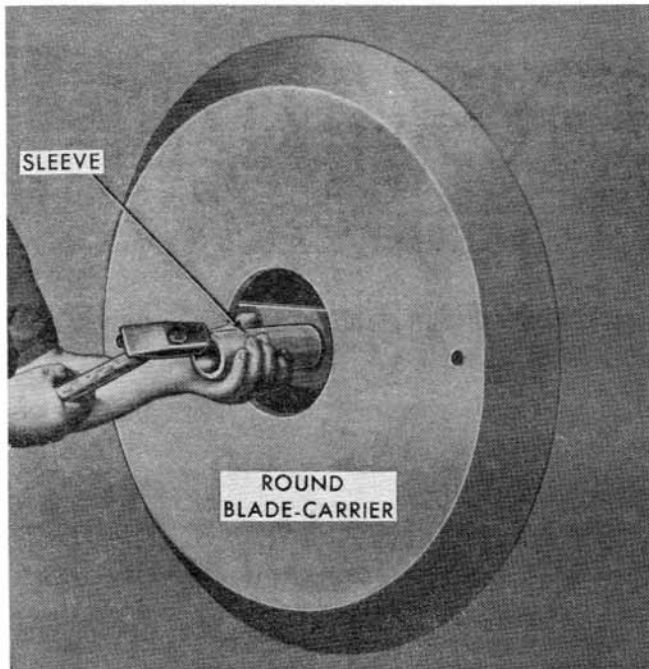

*Figure 8*

*Seating Splined Areas – Model 22-195*

### SHEAR BOLT DRIVE LINES

If the cutter blades hit an obstruction, causing the shear bolts, Figure 9, to snap, replace them with the bolts provided with your cutter.

**NOTE:** *If additional shear bolts are required, see your Ford Tractor-Equipment Dealer. Ask for Part No. 302659-S8 (not heat treated).*

If it is necessary to remove the drive shaft assembly from the cutter input shaft it can be done by removing the shear bolts, Figure 9, and the snap ring and heat-treated washer shown in Figure 10.

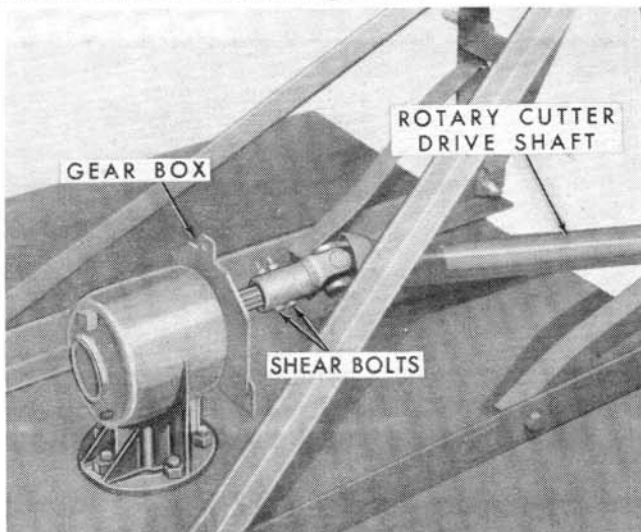

*Figure 9*

*Shear Bolt Drive Line*

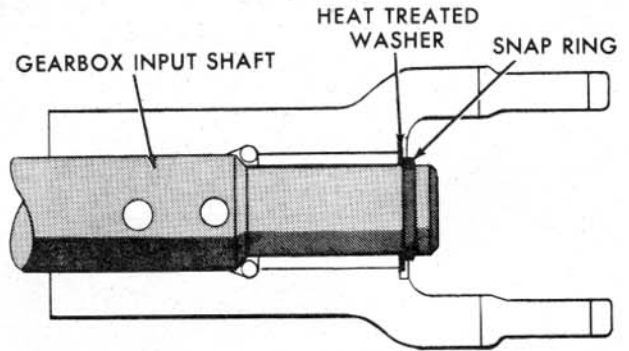

*Figure 10*

*Shear Bolt Drive Line*

### SLIP CLUTCH DRIVE LINES

The slip clutch drive assembly is pre-set at the factory and is locked in position by a set screw on the adjusting nut, Figure 11. If the clutch becomes warm to the touch, the clutch is slipping excessively. To adjust the clutch:

1. Loosen the set screw, Figure 11.
2. Turn the adjusting nut until the Belleville washers are flat against the clutch plate.
3. Back off the adjusting nut 3/4 of a turn and tighten the set screw.

If it is necessary to remove the drive shaft assembly from the cutter input shaft it can be done by removing the snap ring from the groove in the input shaft that is located between the clutch assembly and yoke

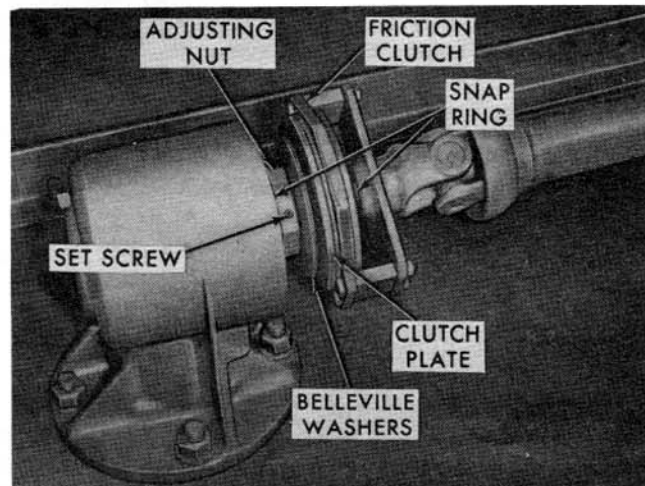

*Figure 11*

*Slip Clutch Drive Line*

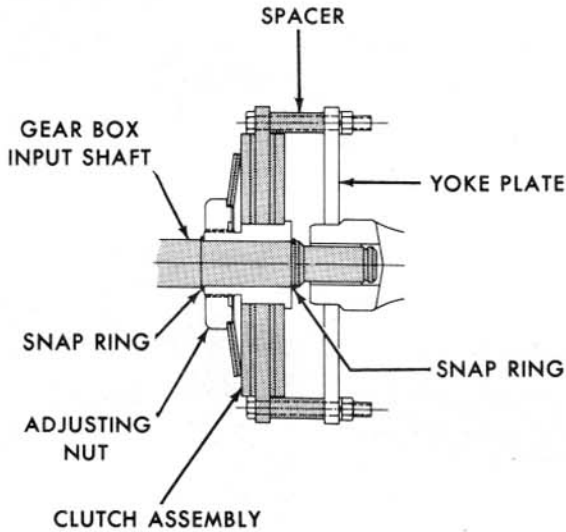

**Figure 12**  
**Slip Clutch Drive Line**

plate, Figure 12. It is not necessary to remove the snap ring that is located behind the adjusting nut. When installing the assembly, loosen the spacer

bolts, then retighten the bolts after the assembly is installed.

## STORAGE

The Ford 60-Inch, Series 908 Rotary Cutter represents an investment from which you should get the the greatest possible benefit. Therefore, when the season is over, the cutter should be thoroughly checked and prepared for storage so that a minimum amount of work will be required to put it back into operation for the next season. The following are suggested storage procedures:

1. Thoroughly clean the cutter.
2. Lubricate the cutter as covered on page 8 .
3. Check the cutter for worn or damaged parts. When replacement is necessary, use genuine Ford parts.
4. Store the cutter in a clean, dry place so the skid shoes are resting on blocks.
5. Use Ford Spray Touch-up Enamel where necessary to prevent rust and to maintain the appearance of the cutter.

## ATTACHMENTS

The following rotary cutter attachments are sold separately by your Ford Tractor-Equipment Dealer.

### Chain Link Guard Kit, Part No. 220296

The chain link guard kit is designed to reduce flying debris when excessive trash creates hazardous operating conditions. The kit attaches to the front of the cutter. Installation is covered on page 15.

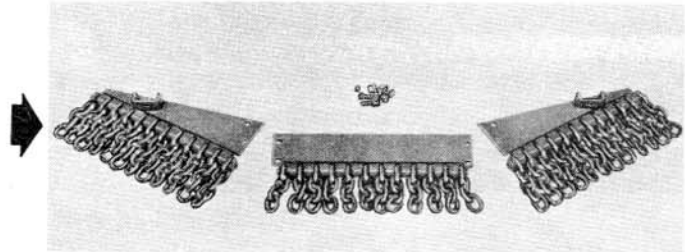

### Front Safety Shield Kit, Part No. 221022

The front safety shield kit is available for use when cutting in stoney soil or in areas littered with foreign material, such as highway shoulders and ditches. The safety shields are useful in mulching to provide a greater pulverization effect. Refer to page 15 for installation procedures.

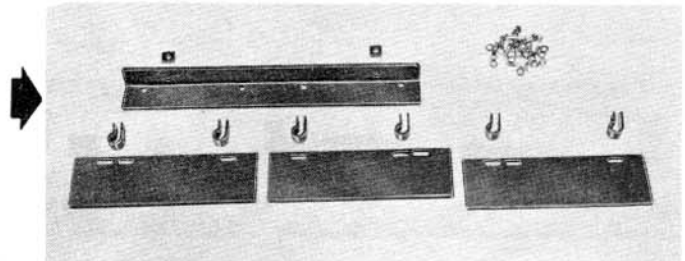

### Suction Blades, Part No. 221854

The 21-7/8'' suction blades aid in lifting the material for more complete cutting. They should be used in place of the standard blades where more complete pulverization is desired or where the material to be cut is down close to the ground. The suction blades are also very useful in leaf mulching operations. Refer to page 16 for installation procedures.

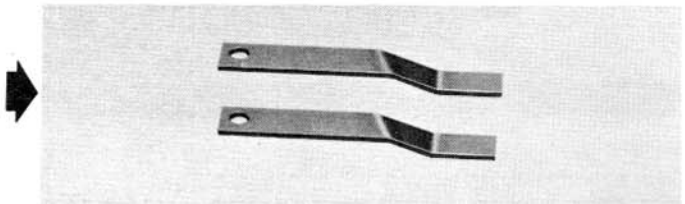

# ATTACHMENTS

## Hook Blades, Part No. 150003

The 21-7/8" long hook blades should be used in place of the standard blades when using the rotary cutter for cutting down brush. The hooked end of the blades extend downward and cuts the brush stubble shorter. Refer to page 16 for installation procedures.

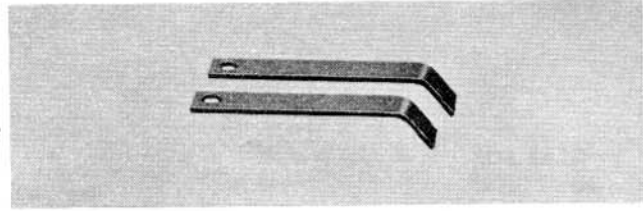

## Flexible A-Frame Bracket, Part No. 221857

The flexible A-frame bracket permits the cutter to "float" with respect to the tractor, thus providing a smoother, more even height-of-cut. This floating action permits the cutter to follow the contour of uneven ground without repeated height adjustments. Refer to page 16 for installation procedures.

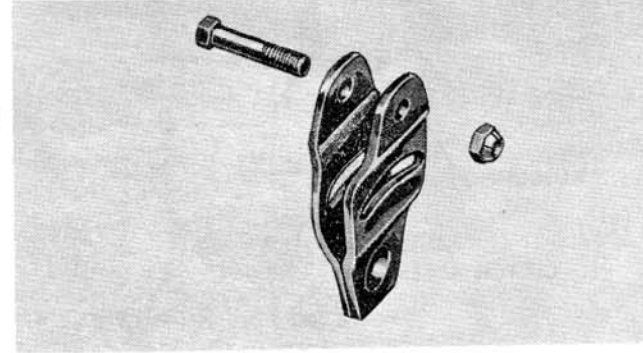

**IMPORTANT:** *The flexible A-frame bracket is not recommended for use with the Ford 2110 or 4110 LCG Tractors because the drive line contacts the front of the cutter frame when the cutter is raised.*

# SHIPPING INFORMATION

## SHIPPING INFORMATION

### GENERAL

The Ford 60-Inch, Series 908 Rotary Cutter and component parts that make up the complete cutter are bundled for shipment in the manner described below. The shipment should be checked against the respective listing and illustrations to make sure all parts have been received.

In addition to the basic rotary cutter frame, a choice of shear pin or slip clutch drive assemblies are available. Gauge wheels are optional and are available in two types. For information pertaining to the various attachments that are available, refer to page 11.

### SERIES 908 ROTARY CUTTER

60-Inch Cutter Frame, Components 22-194 and 22-195

Component No.	Ref.	Description	No. Req.
22-194	22-195	Fig. 13	
X	X	1 Basic Cutter	1
X	X	2 Universal Joint Shield	1
X	X	3 Lynch Pin	1
X	-	4 3/4" - 16 x 2" Carriage Bolt	2
-	X	4 1-1/8" - 12 x 3" Shoulder Bolt	2
X	-	5 Spacer	2
X	-	6 3/4" - 16 Slotted Hex Nut	2

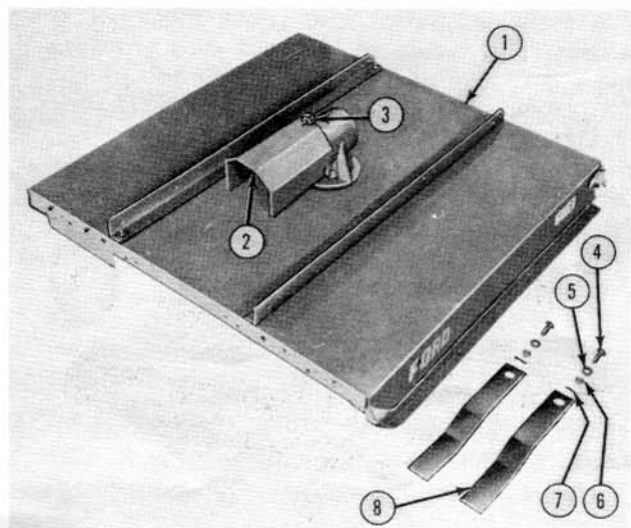

Figure 13

60-Inch Cutter Frame - Component 22-194 Shown

-	X	6	1-1/8" - 12 Hex Lock Nut	2
X	-	7	1-1/8" x 1-1/2" Cotter Pin	2
X	X	8	Cutter Blade, 21-1/8" Long	2
X	-	Not Shown	Straight Blade Carrier	1
-	X	Not Shown	Round Blade Carrier	1

Parts Shipped w/cutter Frame.  
Components 22-194 and 22-195

Ref. Fig. 14	Description	No. Req.
1	Link Bracket Assembly	2
2	Hitch Brace, R.H.	1
3	Hitch Brace, L.H.	1
4	Link Bracket Brace, L.H.	1
5	Link Bracket Brace, R.H.	1
6	Link Bracket Spacer	1
Not Shown	Bag of Attaching Hardware consisting of:	
	5/8" - 11 x 4-1/2" Hex Head Bolt	1
	5/8" - 11 Lock Nut	9
	5/8" - 11 x 1-3/4" Hex Head Bolt	6
	5/8" - 11 x 2" Hex Head Bolt	2
Not Shown	Front Safety Shield	1
Not Shown	Gauge Wheel Support Assembly	1
Not Shown	8" x 2-1/2" Wheel and 16" Carcass Tire	1

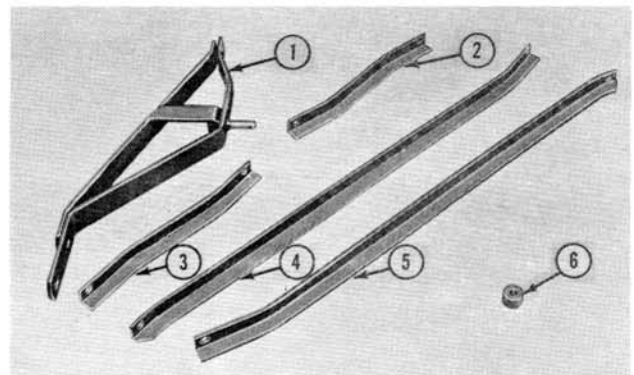
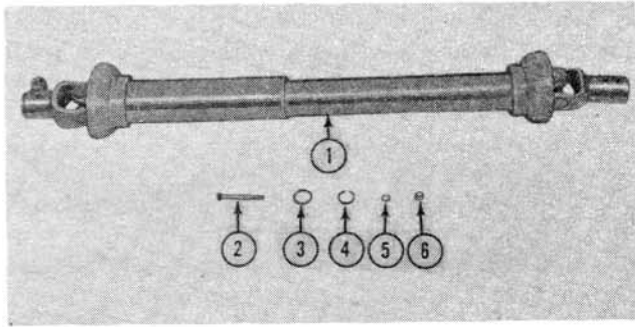

Figure 14

Parts Shipped with the Rotary Cutter Frame



**Figure 15**

Shear Bolt Drive Shaft Assembly – Component 22-128

Shear Bolt Drive Shaft Assembly, Component 22-128

Ref. Fig. 15	<u>Description</u>	No. Req.
1	Universal Drive Shaft Assembly	1
2	5/16'' – 18 x 2-3/4'' Hex Head Bolt (Shear not Heat-treated)	6
3	57/64'' Heat-Treated Washer	1
4	Snap Ring	1
5	5/16'' – 18 Lock Washer	6
6	5/16'' – 18 Hex Nut	6

Slip Clutch Drive Shaft Assembly, Component 22-166

Ref. Fig. 16	<u>Description</u>	No. Req.
1	Universal Drive Shaft Assembly	1
2	Bag of Loose Parts consisting of: Retaining Ring	2

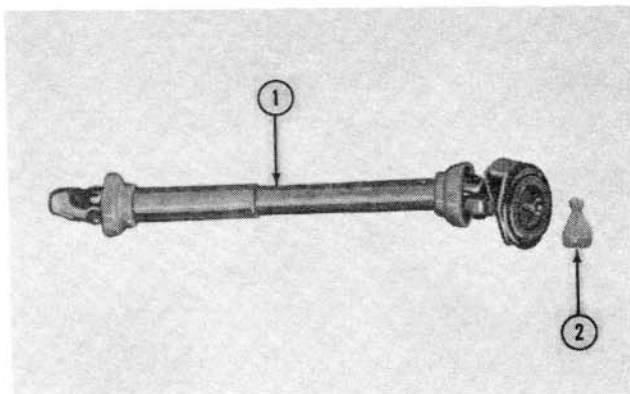

**Figure 16**

Slip Clutch Drive Shaft Assembly – Component 22-147

## ASSEMBLY

### GENERAL INFORMATION

Assembly of the Ford Series 908, 60-Inch Rotary Cutter is the responsibility of the Ford Tractor-Equipment Dealer. The cutter should be delivered to the owner completely assembled. Prior to starting assembly, check the contents of all bundles and kits to be sure all parts have been received.

### BASIC FRAME

1. Attach the link bracket assemblies to the cutter frame at (3), Figure 17, with the 5/8'' – 11 x 2'' hex head bolts, and 5/8'' – 11 lock nuts. Do not tighten until all parts are assembled.
2. Secure the hitch braces to the inside of the link bracket assemblies and to the inside of the cutter frame at (2) and (4) with the 5/8'' – 11 x 1-3/4'' hex head bolts and 5/8'' – 11 lock nuts.
3. Attach the lower end of the L.H. and R.H. link bracket braces to the outside of the cutter frame at (5) with the 5/8'' – 11 x 1-3/4'' hex head bolts and 5/8'' – 11 lock nuts. Make sure the lock nuts are on the outside of the link bracket braces if a gauge wheel is to be installed.
4. Attach the upper end of the L.H. and R.H. link bracket braces to the link bracket assemblies with the 5/8'' – 11 x 4-1/2'' hex head bolt, spacer, and 5/8'' – 11 lock nut as shown in Figure 18.
5. Tighten all nuts and bolts.

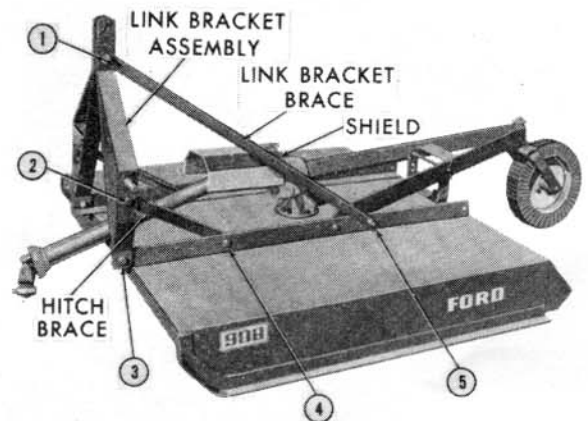

**Figure 17**

Series 908 Cutter Assembled with Gauge Wheel

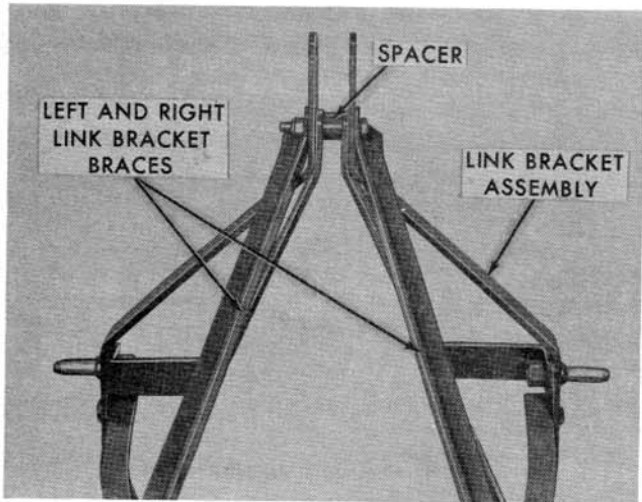

**Figure 18**  
*Link Bracket Braces Attached to Link Bracket Assemblies*

## DRIVE SHAFT ASSEMBLIES

1. **Shear Bolt:** Attach the shear bolt drive shaft assembly to the input shaft of the gearbox with two 5/16" – 18 x 2-3/4" hex head bolts (not heat-treated), lock washers, and nuts as shown in Figure 9.
2. **Shear Bolt:** Install the 57/64" heat-treated washer and snap ring as shown in Figure 10.
3. **Slip Clutch:** Loosen the spacer bolts, Figure 12, to facilitate assembly.
4. **Slip Clutch:** Place a snap ring against the shoulder of the input shaft, then install the drive shaft assembly over the shaft as shown in Figures 11 and 12. Retain the assembly by installing a second snap ring, then tighten the spacer bolts.
5. Attach the universal joint shield to the gearbox as shown in Figure 17, with the lynch pin provided.

## Gauge Wheel Support Assembly, Component 22-117

1. Attach the gauge wheel bracket as shown in Figure 20 with two 5/8" – 11 x 2" bolts, lock washers, and lock nuts.
2. Attach the gauge wheel support, Figure 21, to the cutter frame with two 7/16" – 14 x 1-1/2" bolts, flat washers, lock washers, and lock nuts.
3. Secure the support to the bracket with the support rod and cotter hairpins supplied with the attachment.

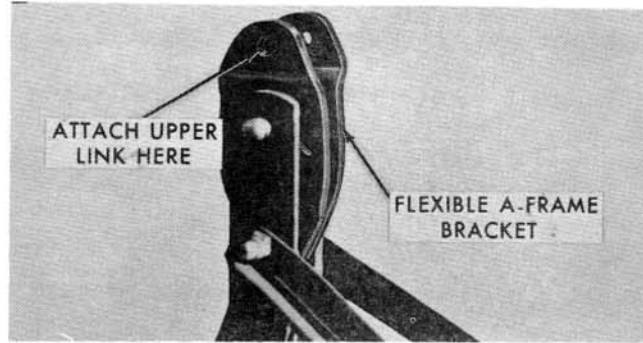

**Figure 19**  
*Flexible A-Frame Bracket Installed*

## Gauge Wheel

1. Bolt the gauge wheel to the hub and bushing assembly at (1), Figure 22, with four 1/2" – 13 x 1-1/4" hex head bolts, lock washers, and nuts.
2. Place the 6-1/16" spacer in the hub, then install a hub bushing over each end of the spacer. Retain the parts by installing a dust cap over each end of the hub.
3. Position the assembled wheel and hub between the fork of the wheel support yoke and retain with the 5/8" – 11 x 8-1/2" hex head bolt, flat washer, lock washer, and hex nut as shown at (2), Figure 22.

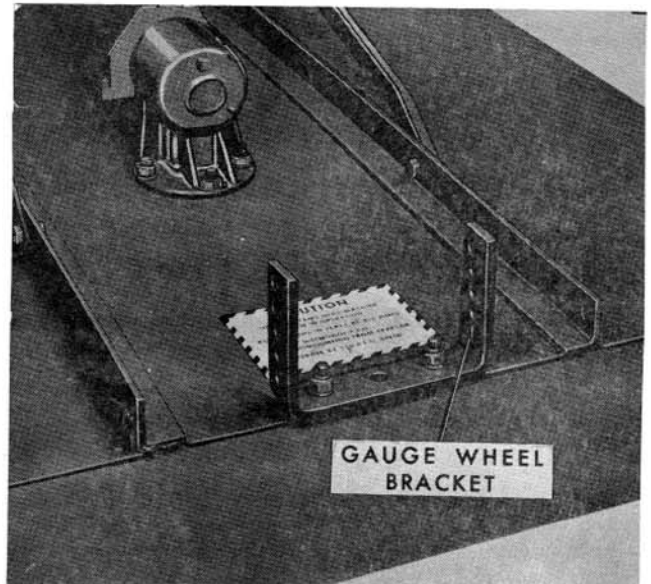

**Figure 20**  
*Gauge Wheel Bracket Installed*

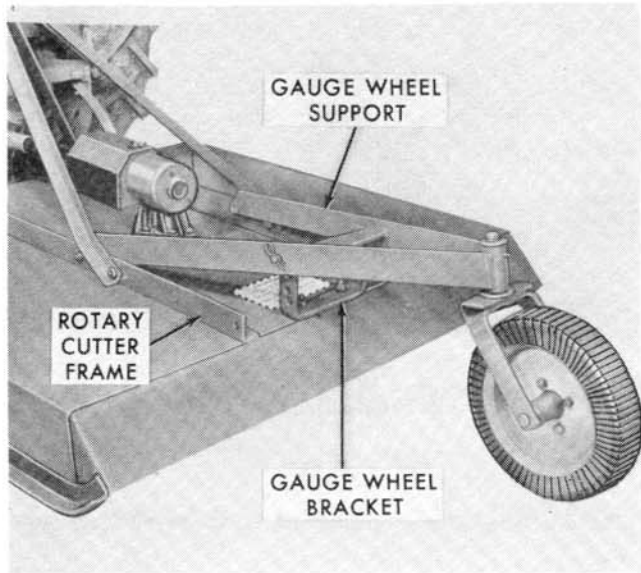

**Figure 21**  
*Gauge Wheel and Support Assembly Installed*

## CUTTING BLADES

If the cutting blades are not already installed, attach them to the blade carrier as covered on page 8, under "Cutting Blade Replacement".

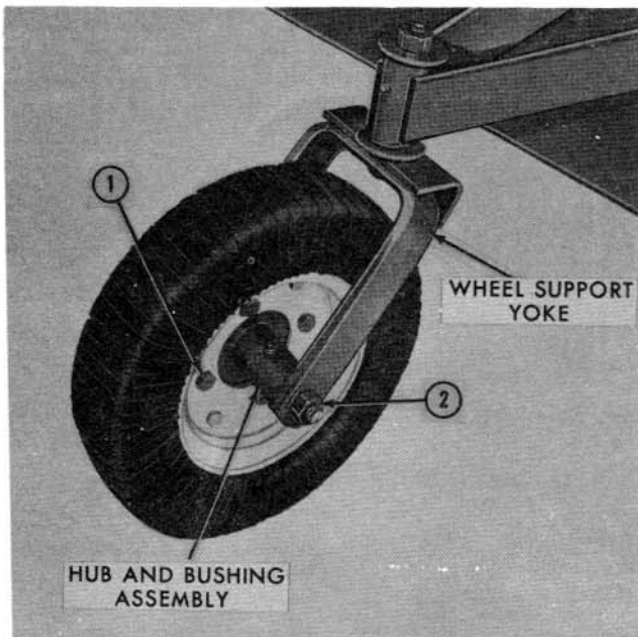

**Figure 22**  
*Carcass-Type Gauge Wheel Installed*

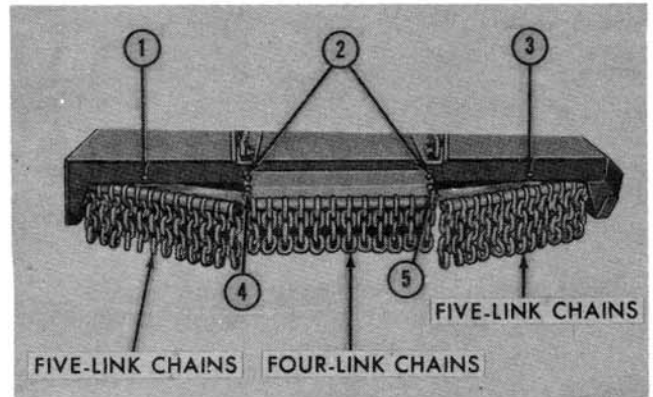

**Figure 23**  
*Chain Link Guard Kit Installed*

## ATTACHMENTS

### Chain Link Guard Kit, Part No. 220296

1. If not already assembled, attach the five-link chains, Figure 23, to the L.H. and R.H. hangers with the rods supplied with the kit. Retain the rods at each end with the flat washers and cotter pins. Assemble the four-link chains to the center hanger in the same manner.
2. Remove the deflector, Figure 13, and attach the L.H. and R.H. guards at (1) and (3), Figure 23, with the 7/16" - 14 x 1-1/4" hex head bolts, washers, and lock nuts that are provided with the kit.
3. Attach the center guard at (2) with the other two 7/16" - 14 x 1-1/4" hex head bolts and lock nuts.
4. Bolt the L.H. and R.H. guards to the center guard at (4) and (5) with the four 7/16" - 14 x 1" hex head bolts and lock nuts.

### Front Safety Shield Kit, Part No. 7001022

1. Attach the safety shield bracket to the front of the cutter frame with two 5/16" - 18 x 1-1/2" bolts, lock washers, and nuts. See Figure 24.
2. Attach two of the shields to the bracket and the third shield to the cutter frame with the hangers and the 5/16" - 18 x 1-1/2" bolts, lock washers, and nuts that are provided with the kit.

### Suction Blades, Part No. 221854 and Hook Blades, Part No. 150003

Attach the suction blades or the hook blades to the blade carrier as covered on page 8 under "Cutting Blade Replacement".

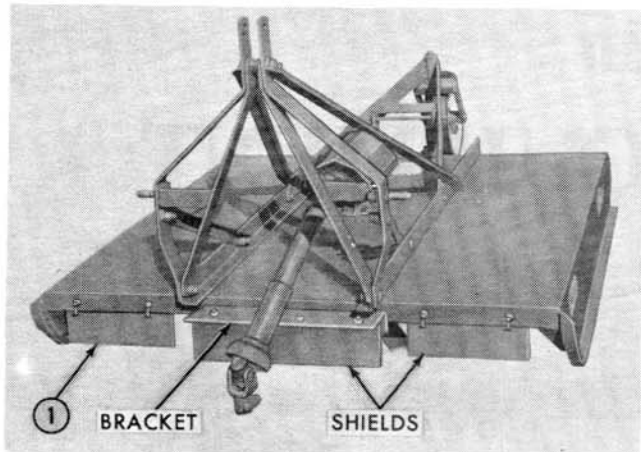

**Figure 24**  
*Front Safety Shield Kit Installed*

## **Flexible A-Frame Bracket, Part No. 221857**

1. Attach the flexible A-frame bracket, Figure 19, to the top hole in the link bracket assemblies with the 3/4" - 10 x 3-3/4" bolt and lock nut. Tighten the lock nut so the attachment is free to pivot.
2. Remove the bolt and spacer, Figure 18, from the bottom of the link bracket assemblies. Place the spacer in the bottom hole of the A-frame bracket, then reinstall the bolt through the A-frame bracket, spacer, and link bracket assemblies, as shown in Figure 19. Install and tighten the lock nut.



the **SPOTLIGHT** is on

# FORD EQUIPMENT

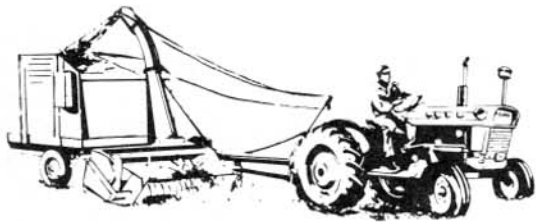

FORAGE HARVESTERS

PLOWS



LOADERS

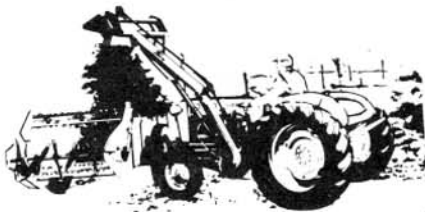

PLANTERS

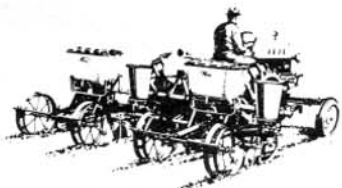

ROTARY HAY CUTTERS

DISC HARROWS



CULTIVATORS

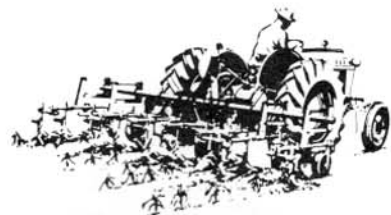

BLADES



SEE YOUR LOCAL  
**FORD TRACTOR —  
EQUIPMENT DEALER**

HAY BALERS



CORN PICKERS



*whatever your service needs ...  
whatever your parts or accessories  
requirements... your Ford Tractor  
and Equipment Dealer is equipped  
to serve you better... for less !!!*

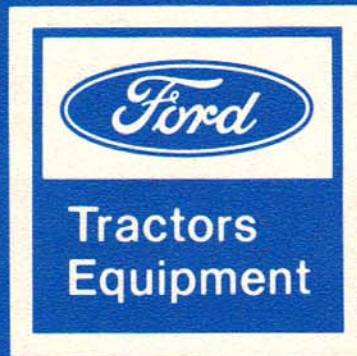

**FORD TRACTOR OPERATIONS**

**FORD MOTOR COMPANY**

**TROY, MICHIGAN 48084**

SE 9430-B 12725

PRINTED IN U.S.A.